

PROJECT	_____
TYPE	_____
SPECIFIER	_____
QUANTITY	_____
DATE	_____

FIN SURFACE

E10C0102-

base number Color Lens
 Temperature Options

- To build a product code in our configurator select the specify button on the base model # product page
- To build a manual product code on this datasheet choose from the options listed below in blue font and add the suffix to the base model #

GENERAL

Series: Fin
 Brand: Side
 Division: Exterior
 Mounting Type: Surface
 Mounting Location: Above Ground
 Subcategory: Wallwash

PHYSICAL

Shape: Rectangle
 Length (mm): 680
 Length (in): 26 ³/₄
 Width (mm): 30
 Width (in): 1 ³/₁₆
 Height (mm): 28
 Height (in): 1 ¹/₈
 Light Distribution: Adjustable / Direct
 Weight (kg): 0.5
 Weight (lbs): 1.1
 Diffuser: Transparent Methacrylate
 Fixture Finish: ANA
 Fixture Material: Extruded Aluminum

ELECTRICAL

Lamp Type: LED (Zhaga Standard)
 Input Wattage (W): 18
 Total Output Wattage (W): 17
 Dimming: 0-10V Dimming / Phase Dimming (120Vac Only)
 Driver Included: No
 Driver Location: Remote
 Driver Type: Constant Current - Universal
 Driver Class: Class 2
 Input Voltage (V): 120 - 277
 Constant Current (MA): 500

LED

Color Temperature (°K): 3000 / 4000
 Max. Delivered Lumen (lm): 1116.6 / 1326
 Nominal Lumen (lm): 1600 / 1900
 CRI: >80 CRI
 Lamp Life (hrs): 50000

OPTICAL

Optic°: 25 / 35 / ELL with an Eyelid

RATINGS AND CERTIFICATIONS

Certified By: Certified for North American Standards
 IP rating: IP65
 IK Rating: IK06

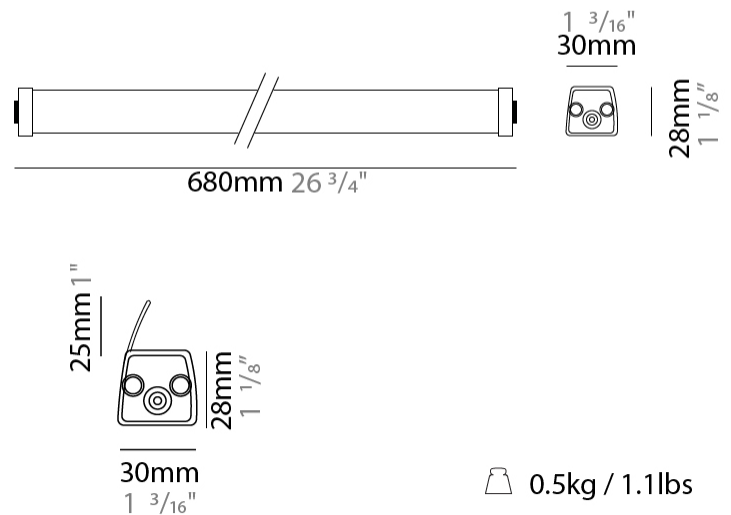

FIN SURFACE

E10C0102-

PROJECT

TYPE

SPECIFIER

QUANTITY

DATE

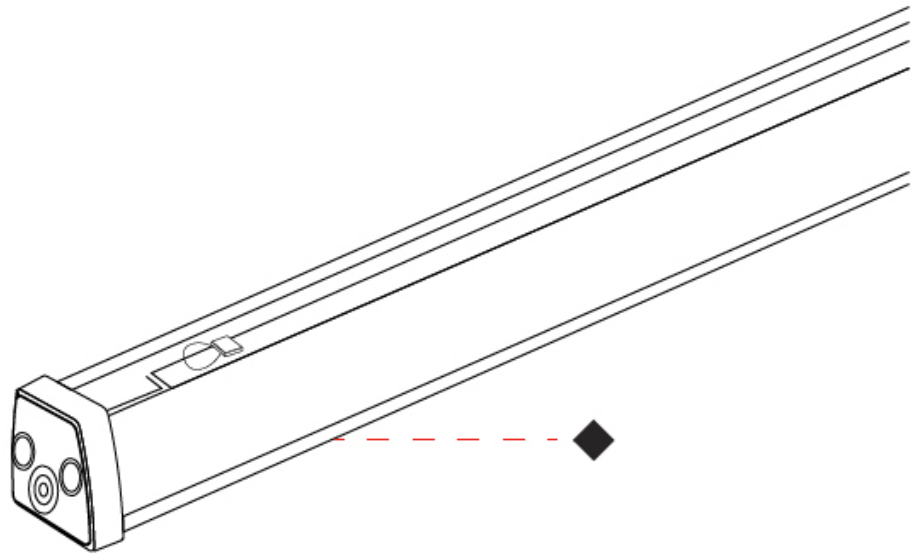

E

PROJECT
TYPE
SPECIFIER
QUANTITY
DATE

FIN SURFACE

E10C0108-

base number Color Lens
 Temperature Options

- To build a product code in our configurator select the specify button on the base model # product page
- To build a manual product code on this datasheet choose from the options listed below in blue font and add the suffix to the base model #

GENERAL

Series: Fin
 Brand: Side
 Division: Exterior
 Mounting Type: Surface
 Mounting Location: Above Ground
 Subcategory: Wallwash

PHYSICAL

Shape: Rectangle
 Length (mm): 1027
 Length (in): 40 7/16
 Width (mm): 30
 Width (in): 1 3/16
 Height (mm): 28
 Height (in): 1 1/8
 Light Distribution: Adjustable / Direct
 Weight (kg): 0.750
 Weight (lbs): 1.65
 Diffuser: Transparent Methacrylate
 Fixture Finish: ANA
 Fixture Material: Extruded Aluminum

ELECTRICAL

Lamp Type: LED (Zhaga Standard)
 Input Wattage (W): 29.5
 Total Output Wattage (W): 25.5
 Dimming: 0-10V Dimming / Phase Dimming (120Vac Only)
 Driver Included: No
 Driver Location: Remote
 Driver Type: Constant Current - Universal
 Input Voltage (V): 120 - 277
 Constant Current (MA): 500

LED

Color Temperature (°K): 3000 / 4000
 Max. Delivered Lumen (lm): 2124 / 2522.3
 Nominal Lumen (lm): 2400 / 2850
 CRI: >80 CRI
 Lamp Life (hrs): 50000

OPTICAL

Optic°: 25 / 36 / ELL

RATINGS AND CERTIFICATIONS

Certified By: Certified for North American Standards
 IP rating: IP65
 IK Rating: IK06

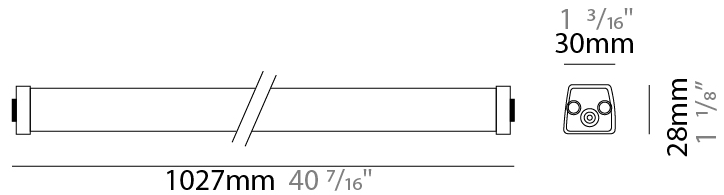

0.75kg / 1.65lbs



FIN SURFACE

E10C0108-

PROJECT	_____
TYPE	_____
SPECIFIER	_____
QUANTITY	_____
DATE	_____

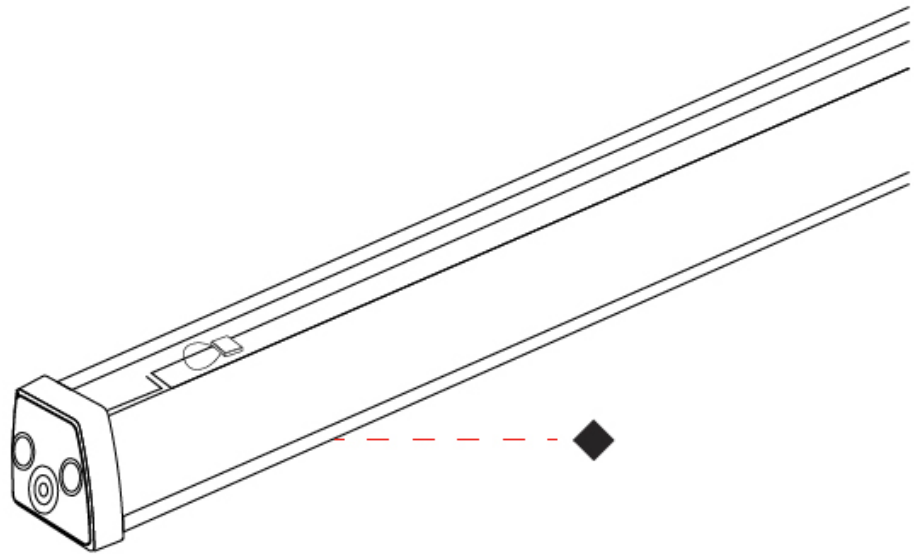

PROJECT
TYPE
SPECIFIER
QUANTITY
DATE

FIN SURFACE

E10C0114-

base number Color Lens
 Temperature Options

- To build a product code in our configurator select the specify button on the base model # product page
- To build a manual product code on this datasheet choose from the options listed below in blue font and add the suffix to the base model #

GENERAL

Series: Fin
 Brand: Side
 Division: Exterior
 Mounting Type: Surface
 Mounting Location: Above Ground
 Subcategory: Wallwash

PHYSICAL

Shape: Rectangle
 Length (mm): 1027
 Length (in): 40 7/16
 Width (mm): 30
 Width (in): 1 3/16
 Height (mm): 28
 Height (in): 1 1/8
 Light Distribution: Adjustable / Direct
 Weight (kg): 0.75
 Weight (lbs): 1.65
 Diffuser: Transparent Methacrylate
 Fixture Finish: ANA
 Fixture Material: Extruded Aluminum

ELECTRICAL

Lamp Type: LED (Zhaga Standard)
 Input Wattage (W): 26
 Total Output Wattage (W): 25.5
 Dimming: 0-10V Dimming / Phase Dimming (120Vac Only)
 Driver Included: No
 Driver Location: Remote
 Driver Type: Constant Current - Universal
 Driver Class: Class 2
 Input Voltage (V): 120 - 277
 Constant Current (MA): 500

LED

Color Temperature (°K): 3000 / 4000
 Max. Delivered Lumen (lm): 1675 / 1989
 Nominal Lumen (lm): 2400 / 2850
 CRI: >80 CRI
 Lamp Life (hrs): 50000

OPTICAL

Optic°: 25 / 35 / ELL with an Eyelid

RATINGS AND CERTIFICATIONS

Certified By: Certified for North American Standards
 IP rating: IP65
 IK Rating: IK06

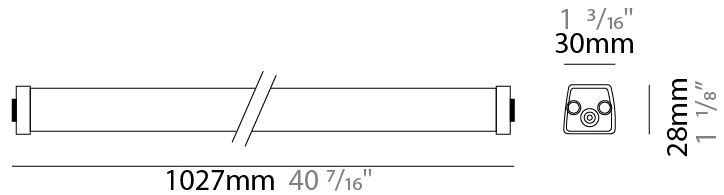

0.75kg / 1.65lbs



FIN SURFACE

E10C0114-

PROJECT	_____
TYPE	_____
SPECIFIER	_____
QUANTITY	_____
DATE	_____

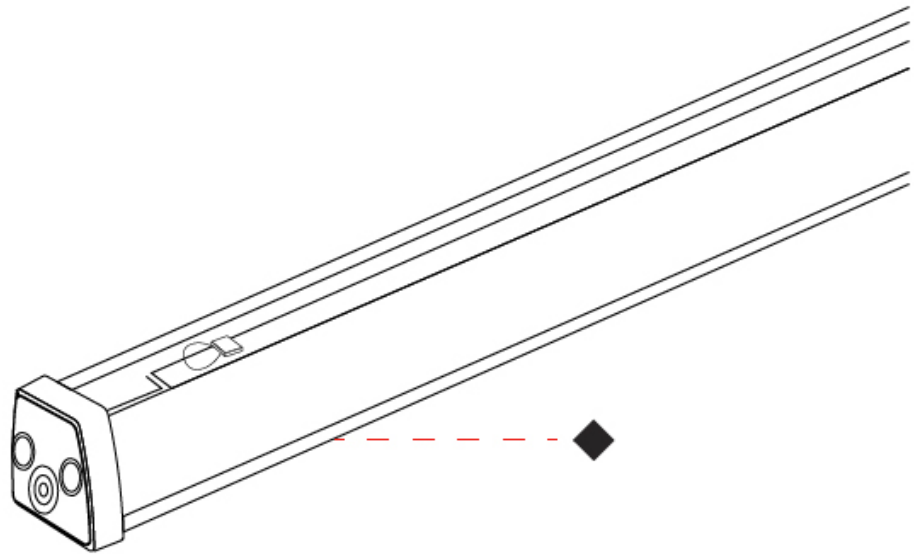

E

PROJECT

TYPE

SPECIFIER

QUANTITY

DATE

Fixture Finish

Anodized Aluminum - ANA

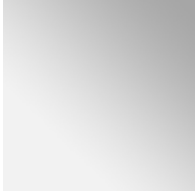

Digital: Not all screens are calibrated the same, and therefore, colors will appear differently between screens.











Physical: When texture is involved, there will be variations in color, character and tone within a product series and between product families.













LEGEND

 floor-mounted	 pivotable	 special LED (upon request) RGB, RGBW, tunable, gold+, meat+, art+, fashion+
 wall and ceiling: recessed and surface mounted	 rotating	 warm dim / natural dimming LED
 ceiling-mounted and wall-mounted	 illuminate tilted	 rechargeable battery powered
 wall-mounted	 color of suspension cable	 fixture with natural vivid LED (upon request)
 omni-directional light distribution	 length of suspension cable	 color rendering index
 direct light distribution	 reflector degree selection	 color temperature
 direct/indirect light distribution	 super spot	 lumen (luminous flux)
 indirect light distribution	 lens	 efficacy (lumens per watt)
 asymmetric light distribution	 lens pack	 Unified Glare Rating (UGR) range from 5-40
 aura light distribution	 shine ring	 marine grade (AISI 316 stainless steel)
 round wall or ceiling cut-out	 integrated shine ring with diffuser	 walk on
 square wall or ceiling cut-out	 free individual colors 01-29	 drive on
 the supplied jig specifies the cutout dimensions	 individual colors: 00 (free of charge), 01-25 (extra charge)	 Dark Sky Compliance
 minimum distance (meters) lamp - object	 luminaire part to be colored (F1)	 Americans with Disabilities Act (less than 4" off the wall located between 27"-84" from floor)
 recessed depth	 luminaire part to be colored (F2)	 lamp protected against explosion
 ceiling thickness in mm	 luminaire part to be colored (F3)	 blown glass using traditional methods by master glass blower
 ceiling thickness selection	 luminaire part to be colored (F4)	 acoustic material
 dimmable DP (phase), DV (0-10V), DD (dali), DS (step-dim)	 luminaire part to be colored (F5)	 protection class I, protection insulation
 included or excluded LED driver/transformer/control gear	 color of 3-circuit adaptor	 protection class II, protection insulation
 separately switchable	 indirect diffuser	 ETL Certified to UL and CSA Standards
 sensor	 direct diffuser	 UL Certified to UL and CSA Standards
 remote control	 ball-proof (upon request)	 CSA Certified to UL and CSA Standards
 available upon request	 accessory	 Certified for North American Standards

IP RATING

 IP20	protected against ingress of solid bodies greater than 12.5mm (finger)
 IP33	protected against ingress of solid bodies greater than 2.5mm protected against sprays of water up to 60 degrees from the vertical (rain)
 IP40	protected against ingress of solid bodies greater than 1mm (wire) no protection against the ingress of moisture
 IP43	protected against ingress of solid bodies greater than 1mm (wire) protected against sprays of water up to 60 degrees from the vertical (rain)
 IP44	protected against ingress of solid bodies greater than 1mm (wire) protected against water splashed from all directions
 IP54	protected against limited ingress of dust (wet rooms/covered outdoor areas) protected against water splashed from all directions
 IP65	protected against ingress of dust protected against jets of water
 IP66	protected against ingress of dust protected against powerful jets of water or heavy seas
 IP67	protected against ingress of dust protected against immersion of water between 15cm - 1m for 30 minutes
 IP68	protected against ingress of dust protected against immersion of water under pressure for long periods

IK RATING

 IK01	protected against 0.14 joules impact (equivalent to 0.25kg mass dropped from 56mm above the surface)
 IK02	protected against 0.2 joules impact (equivalent to 0.25kg mass dropped from 80mm above the surface)
 IK03	protected against 0.35 joules impact (equivalent to 0.25kg mass dropped from 140mm above the surface)
 IK04	protected against 0.5 joules impact (equivalent to 0.25kg mass dropped from 200mm above the surface)
 IK05	protected against 0.7 joules impact (equivalent to 0.25kg mass dropped from 280mm above the surface)
 IK06	protected against 1 joules impact (equivalent to 0.25kg mass dropped from 400mm above the surface)
 IK07	protected against 2 joules impact (equivalent to 0.5kg mass dropped from 400mm above the surface)
 IK08	protected against 5 joules impact (equivalent to 1.7kg mass dropped from 300mm above the surface)
 IK09	protected against 10 joules impact (equivalent to 5.0kg mass dropped from 200mm above the surface)
 IK10	protected against 20 joules impact (equivalent to 5.0kg mass dropped from 400mm above the surface)